

CONTENTS

Important Safety Instructions	2
Introduction	4
Included with the EXA915	5
Important Electrical Considerations	6
Cordless Telephone Privacy	7
Installation	8
Desk or Table top Installation	9
Wall Installation	10
Setting the Handset Retainer	12
Setting Up Your Phone	13
Raising the Antenna	13
Installing the Handset Battery Pack	13
Cleaning the Battery Contacts	14
Charging the Battery Pack	15
Low Battery Indicator	15
Battery Memory Effect	16
Setting the Pulse/Tone Switch	16
Adjusting Ringer/Volume Controls	17
Automatic Digital Code Security	18
Using Your Phone	19
Making and Receiving Calls	19
Changing Channels, Flash, and Page/Find	19
Conference Mode	20
Programming Your Phone	21
Storing a Number in Memory	21
Storing a Mixed Number	22
Dialing a Stored Number	23
Chain Dialing	23
Erasing a Stored Number	24
The Integrated Answering System	25
Features	25
Answering System Setup	26
Turning the Answering System On/Off	26
Setting the Clock	27
Reviewing Time and Day Stamp	28
Setting Your Outgoing Message (OGM)	29
Selecting a Preset OGM	30
VOX/Calling Party Control Feature	31
Using the Reset Button	31
Using Your Answering System	32
Playing New Messages	32
Playing a Stored Message	33
Repeating a Message	34
Skipping a Message	35
Deleting a Message	36
Message Full Indication	37
Voice-Guided Help Menu	38
Screening Incoming Calls	38
Leaving a Memo Message	39
Recording a Telephone Conversation	39
Remote Operation	40
Setting Your PIN Code	40
Using a Touch-Tone Phone	41
Troubleshooting	42
Specifications	44

Important Safety Instructions

When using your telephone equipment, these basic safety precautions should always be followed to reduce the risk of fire, electrical shock, and injury to persons:

1. Read and understand all instructions.
2. Follow all warnings and instructions marked on the product.
3. Unplug this product from the wall outlet before cleaning, and use a dry cloth, without liquid or aerosol cleaners.
4. Do not use this product near water; for example, near a bath tub, wash bowl, kitchen sink or laundry tub, in a wet basement, or near a swimming pool.
5. Do not place this product on an unstable cart, stand, or table. The telephone may fall, causing serious damage to the unit.
6. Slots and openings in the cabinet and the back or bottom are provided for ventilation. To protect the product from overheating, these openings must not be blocked or covered. This product should never be placed near or over a radiator or heat register. This product should not be placed in a built-in installation unless proper ventilation is provided.
7. This product should be operated only from the type of power source indicated on the marking label. If you are not sure of the type of power supply to your home, consult your dealer or local power company.
8. Do not allow anything to rest on the power cord. Do not locate this product where the cord will be damaged by persons walking on it.
9. Do not overload wall outlets and extension cords, as this can result in the risk of fire or electrical shock.
10. Never push objects of any kind into this product through cabinet slots, as they may touch dangerous voltage points or short out parts that could result in a risk of fire or electric shock. Never spill liquid of any kind on the product.
11. To reduce the risk of electric shock, do not disassemble this product. Take it to qualified service personnel when service or repair work is required. Opening or removing covers may expose you to dangerous voltages or other risks. Incorrect reassembly can cause electric shock when the appliance is subsequently used.
12. Unplug this product from the wall outlet and refer servicing to qualified service personnel under the following conditions:
 - A. When the power supply cord is damaged or frayed.
 - B. If liquid has been spilled into the product.
 - C. If the product has been exposed to rain or water.
 - D. If the product does not operate normally when following the operating instructions. (Adjust only those controls that are covered by the operating instructions. Improper adjustment of other controls may result in damage and will often require extensive repair work by a qualified technician.)
 - E. If the product has been dropped or the cabinet has been damaged.
 - F. If the product exhibits a distinct change in performance.
13. Do not use the telephone to report a gas leak in the vicinity of the leak.

Battery Safety Precautions

Caution: *To reduce the risk of fire or injury to persons by the battery, read and follow these instructions:*

1. Use only the appropriate type and size Battery Pack specified in this Operating Guide.
2. Do not dispose of the Battery Pack in a fire. The cell may explode. Check the Nickel-Cadmium Battery Disposal package insert for disposal instructions.
3. Do not open or mutilate the Battery Pack. Released electrolyte is corrosive and may cause damage to the eyes or skin. It may be toxic if swallowed.
4. Exercise care in handling the battery in order not to short the battery with conducting materials such as rings, bracelets, and keys. The battery or conductor may overheat and cause burns.
5. Charge the Battery Pack provided with or identified for use with this product only in accordance with the instructions and limitations specified in the instruction manual provided for this product.
6. Observe proper polarity orientation between the Battery Pack and battery charger.

SAVE THESE INSTRUCTIONS

Introduction

Congratulations on your purchase of the Uniden **EXA915** Cordless Telephone. These phones are designed to exacting standards which provide reliability, long life, and outstanding performance.

Features

- ▷ 40 Channel 900 MHz operation
- ▷ Random Code™ Digital Security
- ▷ AutoTalk™
- ▷ UltraClear Plus
- ▷ AutoStandby™
- ▷ AutoSecure™
- ▷ Speakerphone
- ▷ Page/Find
- ▷ Pulse/Tone Dialing
- ▷ Base/Handset Volume Controls*
- ▷ 10-Number Memory
- ▷ Talk/Battery Low Indicator
- ▷ Redial/Flash
- ▷ 14 Day Battery Life
- ▷ Conference Mode

AutoTalk™ allows you to answer a call by just removing the Handset from the Base so you don't have to waste time pushing buttons or flipping switches. *AutoStandby™* allows you to hang up by simply returning the Handset to the Base.

The *UltraClear Plus* innovative technology, together with 40 different channels, virtually eliminates background noise and provides you with the best possible reception during all of your conversations.

To protect you against misbilled calls which might result from your phone being activated by other equipment, *Random Code™* digital security automatically selects one of over 65 thousand digital security codes for the Handset and Base Units. Also, the *AutoSecure™* feature electronically locks your phone when the Handset is in the Base.

To get the most from your phone, please read this Operating Guide thoroughly. Also be sure to complete the Product Registration form and mail it in.

Be sure to visit our Internet site at <http://www.uniden.com>!

*Handset Volume control not available on all models.

Included with the EXA915

If any of these items are missing or damaged, contact Uniden Customer Service at: (800) 297-1023, 8:00 am to 5:00 p.m. Central, Monday through Friday.



Handset

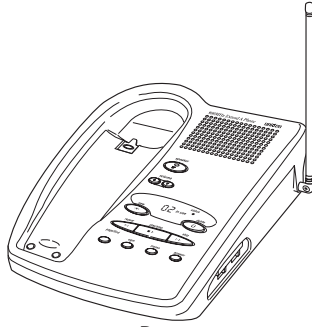

Base

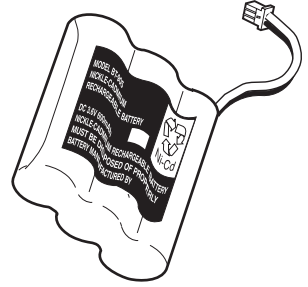

Rechargeable Battery

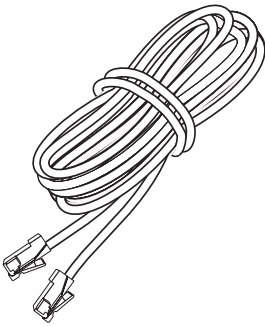

Long Telephone Cord

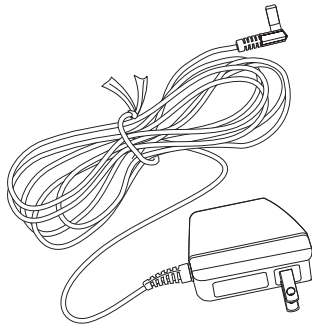

AC Adapter

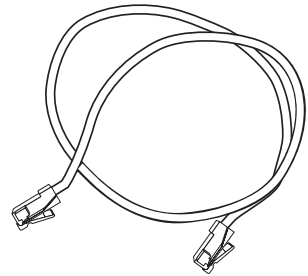

Short Telephone Cord

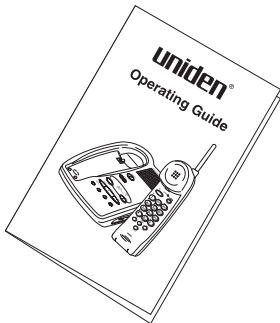

Operating Guide

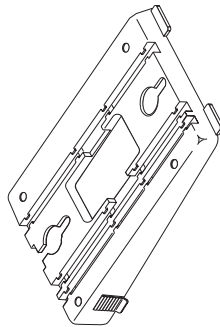

Wall Mount Stand
(Screws Included)

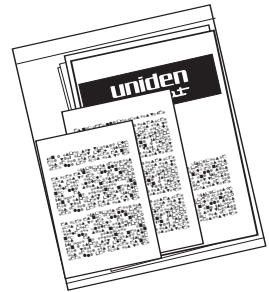

Other Printed Material

Important Electrical Considerations

Unplug all electrical appliances when you know an electrical storm is approaching. Lightning can pass through your household wiring and damage any device connected to it. This phone is no exception.

Warning: *Please do not attempt to unplug any appliance during an electrical storm.*

Caution: *Changes or modifications to this product not expressly approved by Uniden, or operation of this product in any way other than as detailed by this Operating Guide, could void your authority to operate this product.*

Range

Your new phone is designed to achieve the maximum possible range by transmitting and receiving according to the highest specifications set forth by the FCC. We have rated this phone to operate at a maximum distance with the qualification that the range depends upon the environment in which the telephone is used. Many factors limit range, and it would be impossible to include all the variables in our rating. The Maximum Range rating of this phone is meant to be used as a means of comparison against other range claims.

Telephone Line Problems

The FCC has granted the telephone company the right to disconnect service in the event that your phone causes problems on the telephone line. Also, the telephone company may make changes in facilities and services that may affect the operation of your unit. However, your telephone company must give adequate notice in writing prior to such actions to allow you time for making necessary arrangements to continue uninterrupted service.

If you are having trouble with your telephone service, you must first disconnect your phone to determine if it is the cause of your problem. If you determine that it is the cause, you must leave it disconnected until the trouble has been corrected.

Radio Interference

Radio interference may occasionally cause buzzing and humming in your cordless Handset, or clicking noises in the Base Unit. This interference is caused by external sources such as TV, refrigerator, vacuum cleaner, fluorescent lighting, or electrical storm. Your unit is NOT DEFECTIVE. If these noises continue and are too distracting, please check around your home to see what appliances may be causing the problem. In addition, we recommend that the Base not be plugged into a circuit that also powers a major appliance because of the potential for interference. Be certain that the antenna on the unit is fully extended when needed.

In the unlikely event that you consistently hear other voices or distracting transmissions on your phone, you may be receiving radio signals from another cordless telephone or other source of interference. If you cannot eliminate this type of interference, you need to change to a different channel.

Finally, it should be noted that some cordless telephones operate at frequencies that may cause interference to nearby TVs and VCRs. To minimize or prevent such interference, the base of the cordless telephone should not be placed near or on top of a TV or VCR. If interference is experienced, moving the cordless telephone farther away from the TV or VCR will often reduce or eliminate the interference.

More Than One Cordless Telephone

If you want to use more than one cordless telephone in your home, they must operate on different channels. Press the channel key to select a channel that provides the clearest communication.

Cordless Telephone Privacy

Cordless telephones are radio devices. Communications between the handset and base of your cordless telephone are accomplished by means of radio waves which are broadcast over the open airways. Because of the inherent physical properties of radio waves, your communications can be received by radio receiving devices other than your own cordless telephone unit. Consequently, any communications using your cordless telephone may not be private.

Selecting a Location

Before choosing a location for your new phone, there are some important guidelines you should consider:

- ⦿ The location should be close to both a phone jack and continuous power outlet.
 - * *A continuous power outlet is an AC outlet which does not have a switch to interrupt its power.*
- ⦿ Keep the Base Unit and Handset away from sources of electrical noise such as motors or fluorescent lighting.
- ⦿ Be sure there is sufficient space to fully raise the Base Unit antenna.
- ⦿ The Base Unit can be placed on a desk or tabletop or mounted on a standard AT&T or GTE wall plate.
- ⦿ If you decide to mount your phone on the wall, make sure to change the Handset Retainer so that the tab which holds the Handset faces up. (See page 12 for more information.)
- ⦿ You should charge your new phone for 15-20 hours before completing the installation or using the Handset.

Telephone Line Outlets

There are two types of phone outlets:

Modular Jack

Most phone equipment available now uses modular jacks. Phone cords are fitted with a molded plastic connector which plugs into this type of jack. If you do not have modular phone jacks, contact your local telephone company for information about their installation.

Hard-wired Jack

Some equipment is wired directly to a phone jack, and these types of installations require a modular jack converter. This type of installation is not difficult; however, you should contact your Uniden telephone dealer or a telephone supply store for advice about the proper adapter or converter for your particular situation.

Connecting the Telephone Cords

Consider these safety guidelines before connecting the telephone cords:

Caution!

- ⦿ Never install telephone wiring during a lightning storm.
- ⦿ Never touch uninsulated telephone wires or terminals unless the telephone line has been disconnected.
- ⦿ Use caution when installing or modifying telephone lines.

Applying Power to the Base Unit

The **EXA915** phone requires an AC outlet, without a switch to interrupt power, and the included AC Adapter. To relieve strain on the DC plug when the phone is placed on a desk or table, wrap the power cord around the convenient notch below.

* *Place the power cord so that it does not create a trip hazard, or where it could become chafed and create a fire or other electrical hazards.*

* *When power is applied for the first time, or after pushing the **RESET** button, a **P** may appear in the LED display. Press **■▶** on the base to clear the display.*

Desk or Table top Installation

1. Plug the AC Adapter cord into the 9V DC input jack on the Base Unit.

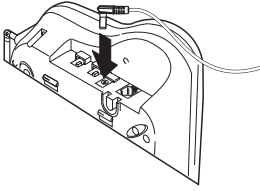

2. Place the AC Adapter cord around the strain relief.

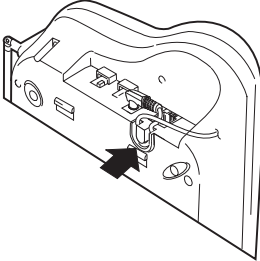

3. Plug one end of the long telephone cord into the **TEL LINE** jack on the Base Unit.

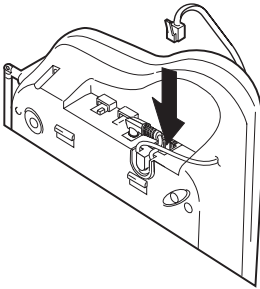

4. Plug the other end of the cord into the telephone jack on the wall.

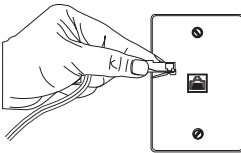

5. Plug the AC Adapter into a standard 120V AC wall outlet.

* *Do not use an outlet controlled by a wall switch.*

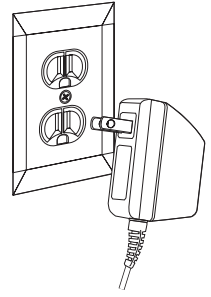

Use only the Uniden AC Adapter supplied with this phone.

Wall Installation

Standard Wall Plate Mounting

These phones are designed to be mounted on a standard AT&T or GTE wall plate.

1. Slide the wall mount stand into the notches at the top of the Base Unit.

Rotate the wall mount stand down and snap it into place.

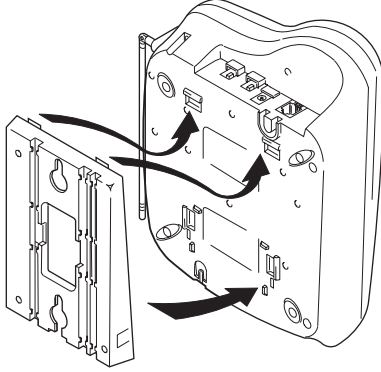

2. Plug the AC Adapter into the Base Unit

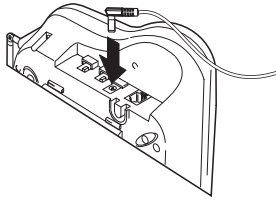

3. Wrap the AC Adapter cord around the strain relief on the Base Unit and place the AC Adapter cord inside the molded channel..

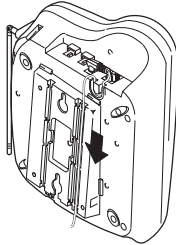

4. Plug one end of the telephone cord into the **TEL LINE** jack on the Base Unit.

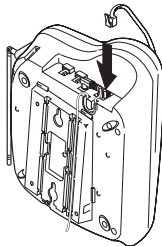

5. Place the telephone cord inside the molded channel on the bottom of the Base Unit.

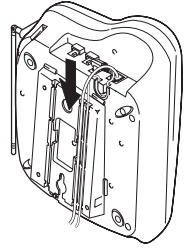

6. Then, plug the other end of the telephone cord into the modular jack on the wall.

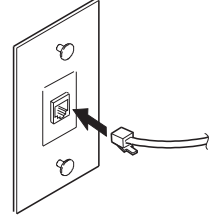

7. Place the Base Unit on the posts of the wall plate and push down until it's firmly seated.

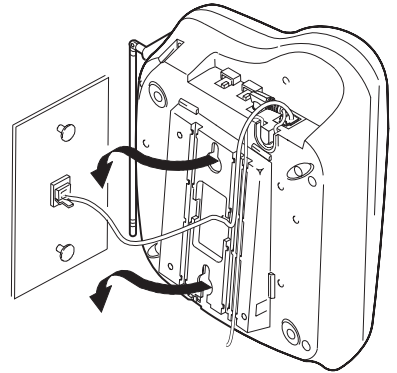

9. Plug the AC Adapter into a standard 120V AC wall outlet.

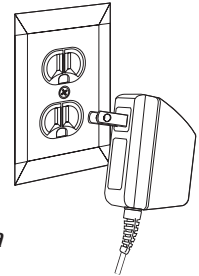

* *Do not use an outlet controlled by a wall switch.*



Use only the Uniden AC Adapter supplied with this phone.

Direct Wall Mounting

If you do not have a standard wall plate, you can mount your phone directly on a wall. Before mounting your phone, consider the following:

- ❑ Select a location away from electrical cables, pipes, or other items behind the mounting location that could cause a hazard when inserting screws into the wall.
- ❑ Make sure the wall material is capable of supporting the weight of the Base Unit and Handset.
- ❑ Use the supplied screws with anchoring devices suitable for the wall material where the Base Unit will be placed.

1. Insert two mounting screws 3-15/16 inches apart. Allow about 3/16 of an inch between the wall and screw heads for mounting the phone.

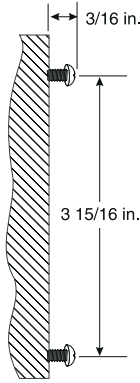

2. Plug the AC Adapter into the Base Unit.

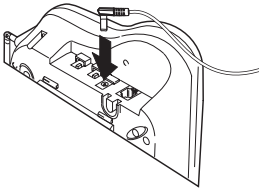

3. Wrap the AC Adapter cord around the strain relief on the Base Unit and place the AC Adapter cord inside the molded channel.

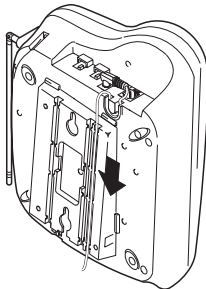

4. Plug one end of the long telephone cord into the **TEL LINE** jack on the Base Unit.

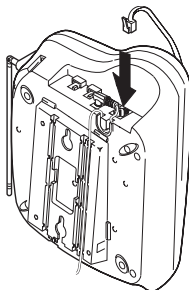

5. Place the cord inside the molded channel on the bottom of the Base Unit.

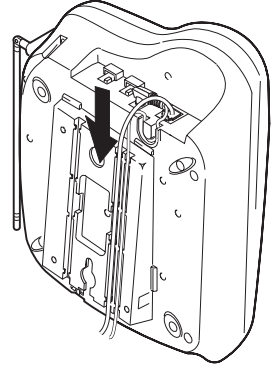

6. Place the Base Unit on the screws and push down until it is firmly seated.

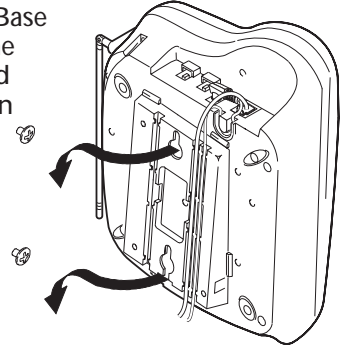

8. Plug the other end of the telephone line cord into the wall jack.

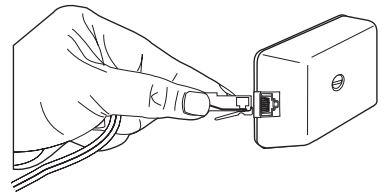

9. Plug the AC Adapter into a standard 120V AC wall outlet.

* *Do not use an outlet controlled by a wall switch.*

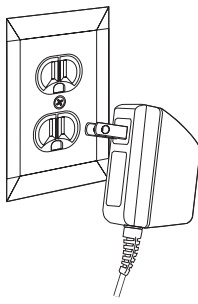

Use only the Uniden AC Adapter supplied with this phone.

Setting the Handset Retainer

The Handset Retainer holds the Handset in place if your phone is mounted on a wall. The steps below describe removing and replacing the retainer so that the tab faces up.

1. Push up on the Handset Retainer on the Base Unit, and slide the tab out.

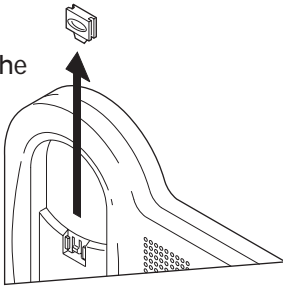

2. Flip the retainer over so the tab faces up.

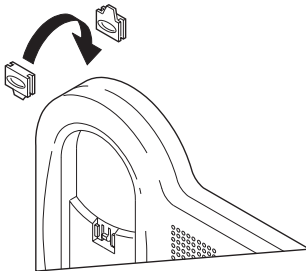

3. Put the retainer back into its slot on the Base Unit.

Push down on the Handset Retainer until it snaps into place.

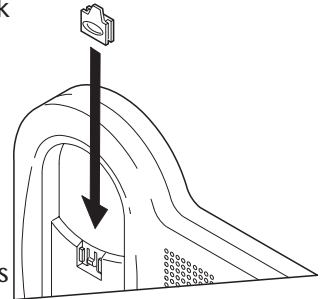

Setting Up Your Phone

Raising the Antenna

Before using your phone, be sure to raise the antenna to the vertical position.

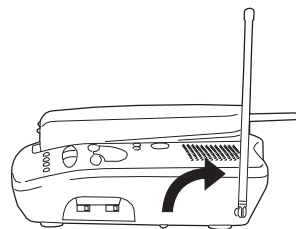

Installing the Handset Battery Pack

1. Press in on the battery cover release.



2. Slide the battery compartment cover down.

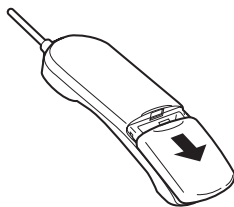

3. Align the plastic connector of the Nickel-Cadmium battery pack with its socket and plug it in.

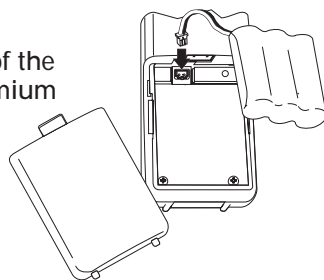

* *The black lead will be on the left when the plug is properly aligned.*

4. Place the battery pack inside the battery compartment and slide the battery cover back on.

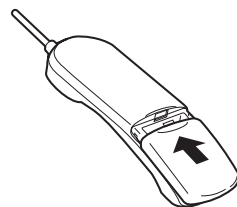

* *The built-in Memory Backup feature allows up to 3 minutes to disconnect the old battery pack and install a new one without losing any numbers stored in memory.*

Correction EXA 915

The instructions for ***Installing the Handset Battery Pack*** are incorrect in your Operating Guide. Use **ONLY** the following instructions to install or replace the Handset Battery Pack in your EXA 915.

Installing the Handset Battery Pack

1. Press in on the Battery Cover release. Slide the battery compartment cover down



2. Align the plastic connector of the Nickel-Cadmium battery pack with its socket and plug it in.

Note: *The black lead will be on the right when the plug is properly aligned.*

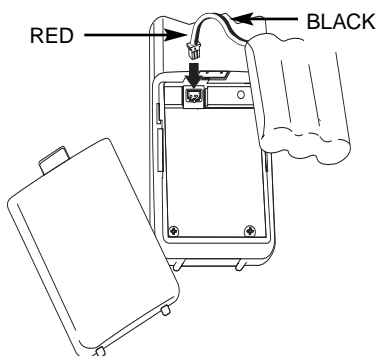

3. Place the battery pack inside the battery compartment, and slide the battery cover back on.

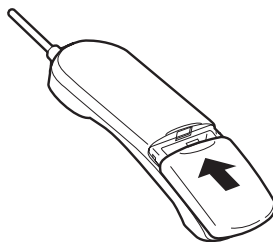

Note: *The built-in Memory Backup feature allows up to 3 minutes to disconnect the old battery pack and install a new one without losing any numbers stored in memory.*

Cleaning the Battery Contacts

To maintain a good charge, it is important to clean all charging contacts on the Handset and Base Unit about once a month. Use a pencil eraser or other contact cleaner. **Do not** use any liquids or solvents.

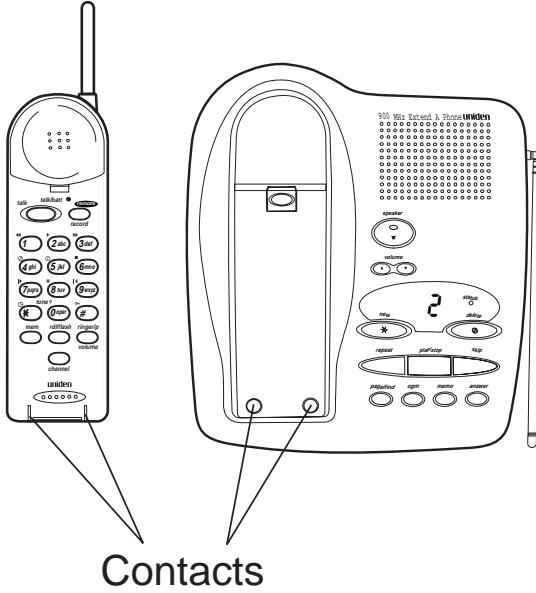

Charging the Battery Pack

Initial Battery Charging

The rechargeable Nickel-Cadmium battery pack must be fully charged before using your phone for the first time. We recommend that the battery pack charge for approximately 15-20 hours, without interruption, before plugging the phone line into your new phone.

1. Place the Handset on the Base Unit.

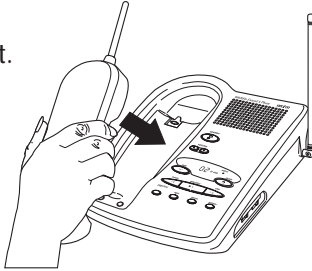

—or—

Hang the handset on the cradle when the phone is mounted on a wall.

- * *Make sure to change the Handset Retainer before hanging up the phone.*

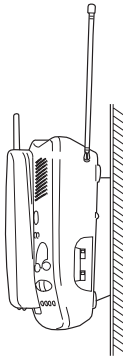

2. Make sure the **status** LED lights. If the LED doesn't light, check to see that the AC Adapter is plugged in, and that the Handset is making good contact with the Base Unit charging contacts.

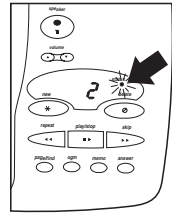

Continuous Battery Charging

For the best battery performance, return the Handset to the Base Unit at the end of the day. This keeps the battery fully charged and avoids the battery "memory effect."

Low Battery Indicator

When the Battery Pack in the Handset is very low and needs to be charged, the **talk/batt low** LED flashes.

If the **talk/batt low** LED begins to flash, the phone is programmed to limit its functions to save power. The table below describes what to do to return your phone to normal operation.

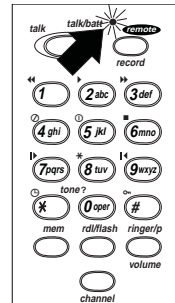

DURING A CALL	IN STANDBY MODE
Only the talk button operates.	None of the buttons will operate.
The Handset beeps and the talk/batt low LED flashes once every 3 seconds.	The Handset talk/batt low LED flashes once every 3 seconds.
Complete your call as quickly as possible.	You will not be able to make a call.
Return the Handset to the Base Unit for charging.	Return the Handset to the Base Unit for charging.

- * *Allow 15 to 20 hours without any interruption for the Handset to fully recharge.*

Battery Memory Effect

Rechargeable batteries can develop a “memory effect” (reduced charge capacity) caused by repeated charge and discharge cycles. The battery life will seem to be shorter every time you use the unit.

To Avoid Memory Effect

At least once a month, operate the unit until the “Battery Low” indicator appears. Avoid “topping off” the charge after using the phone for a short time. Also, do not charge the Rechargeable Battery for extended periods of time.

Setting the Pulse/Tone Switch

Be sure the **PULSE/TONE** switch is in the **TONE** position.

* *Most phone systems are Tone dialing. Check with your local phone company if you are not sure whether your system is Tone or Pulse dialing.*

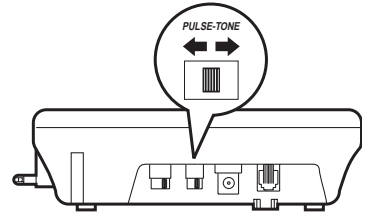

Adjusting Ringer/Volume Controls

Handset Ringer Control

You can also select one of two different ringer tones for the Handset.

Press **ringer/p** to select a different ringer tone when the phone is not in use.

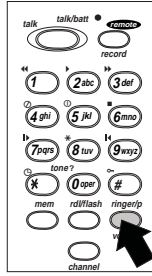

Handset Volume Control

* *Not available on all models.*

You can select one of two Handset volumes from the Handset.

Press **talk**.

Press **ringer/p** / **volume**.

The earpiece volume changes from low to high, or high to low.

Base Volume Controls

To adjust the Base Unit ringer volume, move the **RING VOL-OFF LO HI** switch to the desired setting.

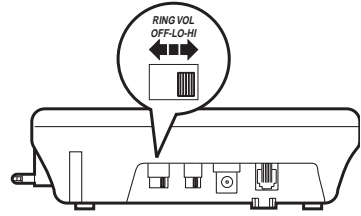

To adjust the Base speaker volume, press the **volume** control switch to achieve the desired setting.

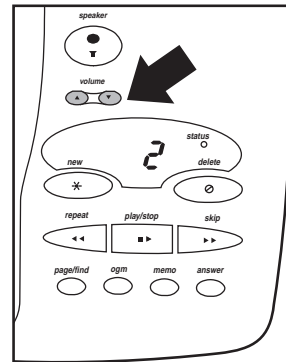

Automatic Digital Code Security

To avoid unauthorized calls on your phone, a Digital Code feature was added to all EXA915 phones. This Digital Code is shared only between the Handset and Base Unit. The code is set *automatically* when you first use the phone.

Changing the digital security code

To change the Digital Code, be sure the Handset is on the Base, then:

1. Press *page/find* on the Base Unit.

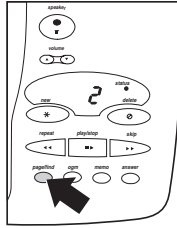

2. After the Handset stops beeping, remove it from the Base Unit.

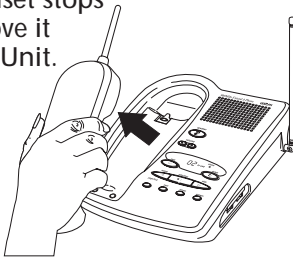

3. Wait 5 seconds then place the Handset on the Base Unit.

The status LED will blink quickly, indicating that the code has changed.

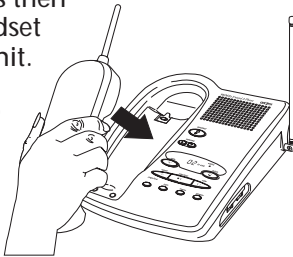

Restoring the digital security code

If the Base Unit loses power while the Handset is off the Base, the Digital Code may be erased. When this happens, the Handset will not function.

To reestablish communication between the Handset and Base Unit:

1. Restore power to the Base Unit.

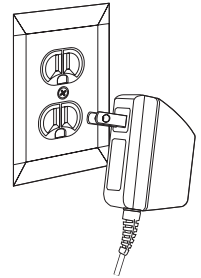

2. Place the Handset back on the Base Unit.

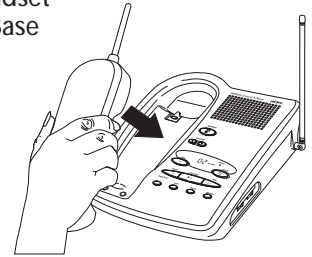



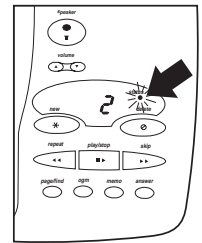

3. The *status* LED will blink quickly, indicating that the Digital Code has been reset.





Using Your Phone

Making and Receiving Calls





The following features of the **EXA915** phone are different depending on the Handset's location when you make or receive a call.

	HANDSET	BASE UNIT
ANSWER CALL	Pick up Handset (<i>AutoTalk</i>) -OR- If the Handset is off the Base: 1) Pick up Handset. 2) Press  .	Press speaker on the Base Unit.
MAKE CALL	1) Pick up Handset. 2) Press  . 3) Listen for dial tone. 4) Dial the number.	<i>Note: You must use the Handset to make a call.</i>
HANG UP	Press  . - OR - Return Handset to Base (<i>AutoStandby</i>).	Press speaker on the Base Unit.
REDIAL	1) Pickup Handset 2) Press  . 3) Listen for dial tone. 4) Press  .	<i>Note: You must use the Handset to make a call.</i>

* Sometimes when you press  to hang up the phone, you may get an error tone and the phone will not disconnect. If this happens, place the Handset on the Base Unit or press  again while holding the Handset close to the Base Unit.





Changing Channels, Flash, and Page/Find

To change channels or access call waiting while the phone is in use, or to use the one-way page to locate the Handset, follow these steps:

	HANDSET	BASE UNIT
CHANGING CHANNELS	Press  . <i>Note: Change channels to help eliminate background noise.</i>	<i>Note: You must use the Handset to change channels.</i>
FLASH	If the call waiting tone sounds, press  to accept the waiting call. - OR - If you have finished a call and want to make another call, press  to hang up and get a dial tone.	<i>Note: The Base Unit does not have  . You must use the Handset for call waiting and to make a call.</i>
PAGE/FIND	<i>Note: When page/find is pressed on the Base Unit, the Handset beeps.</i>	Press page/find on the Base Unit to locate the Handset.

Conference Mode

Three way conversations can be held between the Handset, Base Unit, and another phone. Below is a chart showing how the third person can be added to your conversation, whether you are making the call, or answering the call.

	HANDSET	BASE UNIT
ANSWER CALL	Pick up Handset (<i>AutoTalk</i>) -OR- If the Handset is off the Base: 1) Pick up Handset. 2) Press  .	Press speaker on the Base Unit. Speak into the Base Unit microphone.
MAKE CALL <i>Note: You must use the Handset to make a call.</i>	1) Pick up Handset. 2) Press  . 3) Listen for dial tone. 4) Dial the number.	Press speaker on the Base Unit. Speak into the Base Unit microphone.
HANG UP	Press  . - OR - Return Handset to Base (<i>AutoStandby</i>).	Press speaker on the Base Unit.
REDIAL	1) Pickup Handset 2) Press  . 3) Listen for dial tone. 4) Press  .	<i>Note: You must use the Handset to make a call.</i>

Programming Your Phone

For convenience, the Handset has ten memory locations so you can store the numbers you use most often in either place. Just remember that all programming functions must be completed when your phone is in the standby mode, since the programming keys do not function while you are on the phone.

Storing a Number in Memory

Use these keys to store a number in memory with the Handset.

- * *An error tone will sound and the programming procedure will be canceled if more than 20 seconds elapse between each keystroke entry or step.*

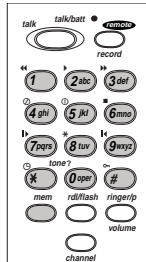

1. Remove the Handset from the Base Unit.

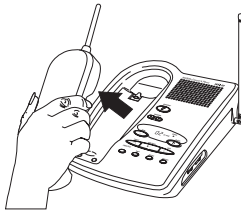

2. Press **mem**.

The talk/batt low LED blinks.

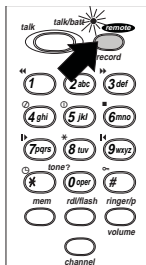

3. Enter the number you want to store (up to 16 digits).

5 jkl 5 jkl 5 jkl 1 2 abc 1 2 abc

4. If a pause is needed during dialing to access a long distance service, press **ringer/p**.

9 wxyz 5 jkl 5 jkl 5 jkl 1 2 abc 1 2 abc

- * *The **ringer/p** button counts as one digit and lasts four seconds. Pressing **ringer/p** more than once increases the length of the pause between numbers.*

5. Press **mem** again.

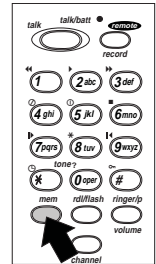

6. Enter the memory location (0-9).

A tone indicates that the number is stored.



Storing a Mixed Number

If your phone is set up for Pulse dialing, you can store a mixed mode number so that you can easily access long distance services.

1. Remove Handset from the Base Unit.

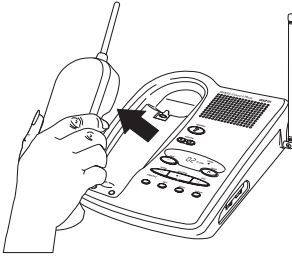

2. Press **mem**.

The talk/batt low LED blinks.

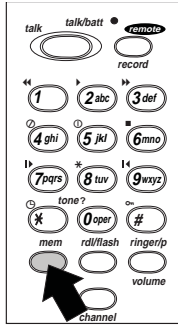

3. Enter the number to be dialed in pulse mode.

5 jkl 5 jkl 5 jkl 1 2 abc 1 2 abc

4. Press ***** on the Handset.

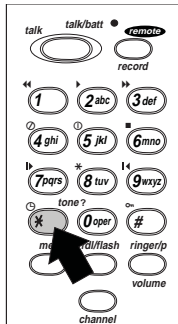

5. Enter the number to be dialed in tone mode.

3 def 3 def 0 oper 0 oper

6. If a pause is needed during dialing to access a long distance service, press **ringerip**.

ringerip 3 def 3 def 0 oper 0 oper

***** *The **ringerip** button counts as one digit and lasts four seconds. Pressing **ringerip** more than once increases the length of the pause between numbers.*

7. Press **mem** again.

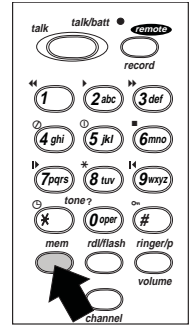

8. Enter the memory location (0-9).

A tone indicates that the number is stored.



Dialing a Stored Number

To dial a number previously stored in memory, follow these steps:

1. Remove the Handset from the Base Unit.

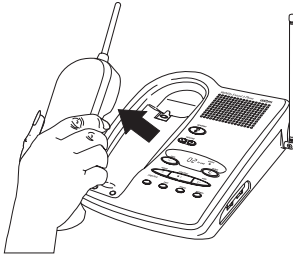

2. Press **talk**.

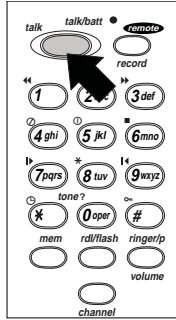

3. Press **mem**.

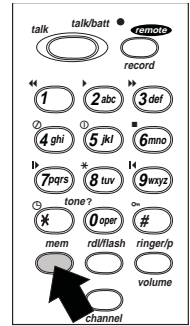

4. Press the memory location number (0-9)

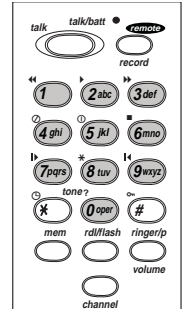

Chain Dialing

On certain occasions, after dialing a number, you may be requested by the party or service you are calling to enter a special access code, such as when performing a banking transaction. To do this, simply:

1. Store the access code into one of the memory numbers.
2. Dial the main number.
3. At the appropriate time, press **mem** followed by the memory location where the access code is saved.

Erasing a Stored Number

To erase a number previously stored in a memory location (0-9), follow these steps:

1. Remove the Handset from the Base Unit.

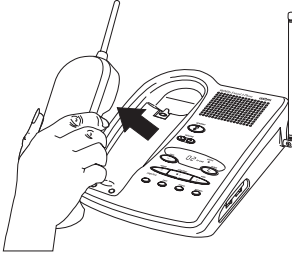

2. Press **mem** twice.

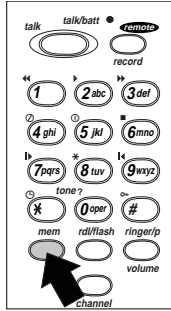

3. Press the memory location number (0-9).

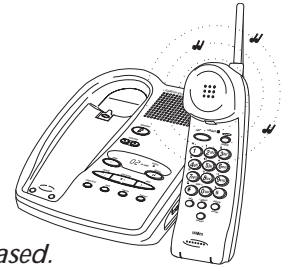

A tone indicates the number is erased.

An error tone will sound and the erase procedure will be canceled if more than 20 seconds elapse between each keystroke entry or step.

The **EXA915** has a *built-in* Answering System which answers incoming calls and records your messages. You can also use your new Answering System to record a conversation, leave a memo message for someone else who will use the phone, or to announce a special message when you'll be away from your phone.

Features

- ▷ Digital Tapeless Recording
- ▷ About 20 Minutes Record Time
- ▷ Remote Operation from Handset
- ▷ Call Screening
- ▷ Selectable Outgoing Messages
- ▷ Automatic Calling Party Control
- ▷ Voice-Guided Help Menu
- ▷ Built in Flash Memory Backup
- ▷ Time and Day Stamp
- ▷ Toll Saver

Digital Tapeless Recording allows you to quickly review your messages, saving or deleting the messages you choose. You'll never have to worry about a tape wearing out or resetting properly.

There is also a Voice-Guided Help Menu available when operating the remote keys from the Handset. By simply pressing one button, you can review all of the function keys on the Handset. You won't have to worry about finding a quick reference card because help is really at your fingertips.

Your **EXA915** is an advanced, integrated system which offers you maximum flexibility, but *please read* through the sections that explain all of the features before using your Answering System.

Turning the Answering System On/Off

Handset Operation

1. To turn the Answering System on, press **remote**.

The **talk/batt low LED** lights green. The current Time and Day Stamp and number of new messages recorded is announced in the Handset receiver.

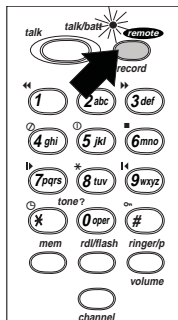

2. Press **1**.

You will hear a tone in the Handset followed by the announcement: "Answering System on."

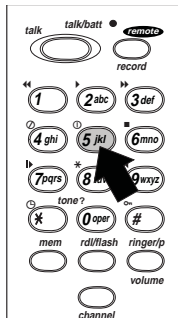

3. Press **remote** again to return to Standby.

The **talk/batt low LED** turns off.

4. To turn the Answering System off, press **remote**.

The **talk/batt low LED** lights green. The current Time and Day Stamp and number of new messages recorded is announced on the Handset receiver.



5. Press **1**.

You will hear a tone in the Handset followed by the announcement: "Answering System off."

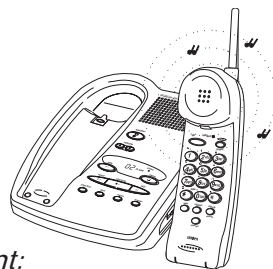

6. Press **remote** again to return to Standby.

The **talk/batt low LED** turns off.

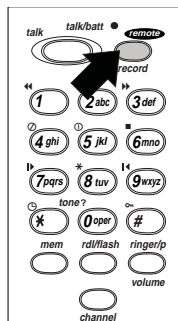

Base Operation

1. To turn the Answering System on, press **answer**.

A tone sounds, and the current outgoing message plays on the Base Unit speaker. A second tone sounds to indicate the unit is ready to answer calls, and the Message Counter LED turns on.

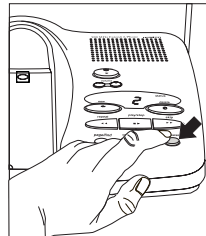

2. To turn the Answering System off, press **answer** again.

A tone sounds and the Message Counter LED turns off.

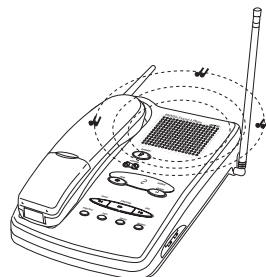

Setting the Clock

The clock in your **EXA915** Answering System starts when power is applied to the Base Unit. Follow these steps to set the clock to the correct time.

1. Press **remote** on the Handset.

The talk/batt low LED lights green.

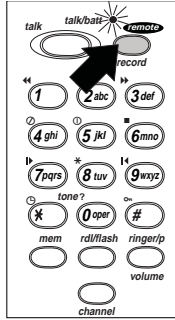

5. Press **remote** to return to Standby.

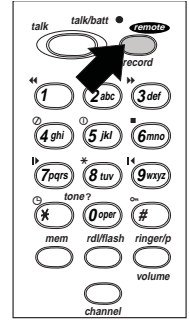

2. Press **⌚**.



6. For example, to set Tuesday at 3:20 PM, press **remote** followed by these keys.



* Remember to press **remote** again to return to Standby.

Then enter the number which corresponds to the day.

Day of the Week	Press
Sunday	1
Monday	2
Tuesday	3
Wednesday	4
Thursday	5
Friday	6
Saturday	7

3. Enter the two-digit number for the hour (01-12) and the minute (00-59).

4. To set AM, press *****.

To set PM, press **#**.

* A beep indicates the new time is programmed, and the new Time and Day Stamp is announced in the Handset receiver.

Reviewing Time and Day Stamp

Handset Operation

1. Press **remote** to hear the current Time and Day Stamp.

The Handset beeps and the Time and Day Stamp is announced, followed by the number of new messages stored in memory. The talk/batt low LED lights green and the Handset beeps.

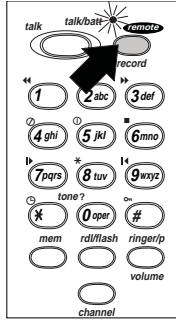

3. Press **remote** again to return to Standby.

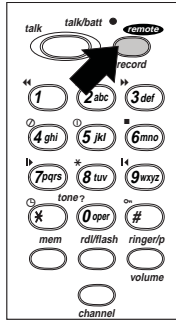

Setting Your Outgoing Message (OGM)

When you receive a call, the Answering System answers and automatically plays either a preset message or your personal Outgoing Message.

Preset Messages

The **EXA915** has two messages programmed in its memory. If the **REC TIME/ANN/4/1** switch is in either the four or one position, the first preset message below plays. Incoming messages are limited to four or one minute respectively. If the switch is set in the left position, (i.e., the "Announce Only" position) the second message below plays, and no incoming messages are recorded.

- Hello. No one is available to take your call. Please leave a message after the tone.
- Hello. No one is available to take your call.

✳ If the **REC TIME/ANN/4/1** switch is in the "Announce Only" position, the Message Counter LED displays an A when the system is in Standby. See number 21 on foldout.

Recording Your Personal OGM

Handset Operation

1. Press **remote**.

The **talk/batt low LED** lights green.

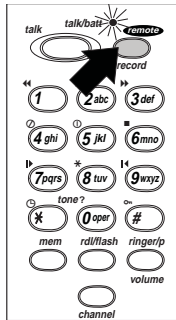

2. Press **▶**.

You can leave up to a 60-second outgoing message.

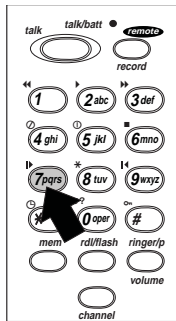

3. Press **▶** to stop recording.

The message replays in the Handset receiver.



4. Press **remote** again to return to Standby.

The **talk/batt low LED** turns off.

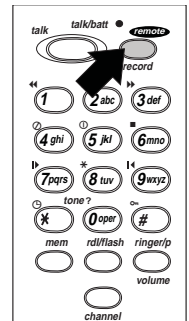

Base Operation

1. To record an outgoing message, press and hold **ogm**.

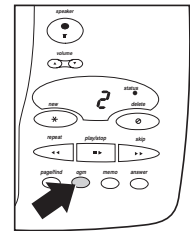

Start recording your message after you hear the long tone and the Message Counter LED begins to count up.

2. Do not get closer than twelve inches from the microphone, and speak clearly while recording your message. When you are finished recording, release **ogm**.

You hear a tone, and your message is played on the Base Unit speaker.

✳ You can leave up to a 60-second outgoing message.

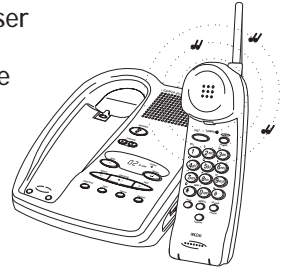

Selecting a Preset OGM

After you have recorded an outgoing message, you can set your Answering System to play either a preset message or your outgoing message.

1. Press **ogm**.

Your recorded outgoing message will begin to play.

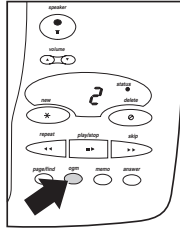

2. While your recorded outgoing message is playing, press **ogm** again.

A tone will sound, and you hear the preset message

"Hello. No one is available to take your call, please leave a message after the tone" on the Base Unit speaker. A second tone sounds after the preset message plays, and the Answering System automatically returns to Standby.

* If the **REC TIME/ANN/4/1** switch is set to **Announce Only**, then the preset message "Hello. No one is available to take your call" is played.



3. To select your recorded message again, press **ogm**.

The preset message will begin to play on the Base Unit speaker.

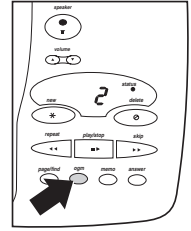

4. While the preset message is playing, press **ogm** again.

A tone will sound, and your recorded message will play on the Base Unit speaker. A second tone sounds after your message plays, and the Answering System automatically returns to Standby.

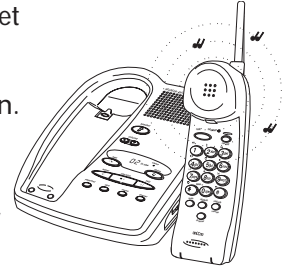

VOX/Calling Party Control Feature

The Calling Party Control (**CPC**) feature automatically sets your Answering System to disconnect and reset if the caller hangs up before leaving a message. This prevents your Answering System from using recording time to record a hang up/dial tone message.

Setting the Toll Saver Switch

The Ring Number/Toll Saver switch allows you to set the number of rings the caller hears before your Answering System answers. You can set the switch to answer after **2** rings or after **4** rings. In the **TS** (Toll Saver) position, the Answering System answers after two rings if you have new messages recorded, and it answers after four rings if there are no new messages. So if you call long distance to check your messages, you can hang up after the second ring and not be billed.

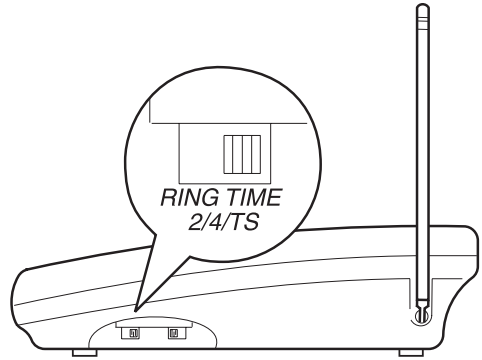

Using the Reset Button

The **RESET** button is used to erase all recorded outgoing messages and any messages which are saved in memory. Pressing **RESET** does not erase your **PIN** (Personal Identification Number) code or the security code between the Handset and Base Unit.

When **RESET** is pressed, the Message Counter begins to flash. See "Applying Power to the Base Unit," for instructions on returning the system to Standby.

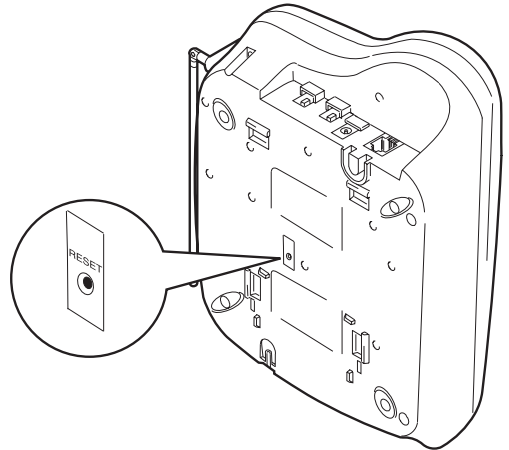

*The **RESET** button may also be used in the unlikely event that an AC power line disturbance causes the answering system to malfunction and become inoperative.*

Playing New Messages

Handset Operation

1. Press **remote**.

The current Time and Day Stamp and number of new messages is announced.

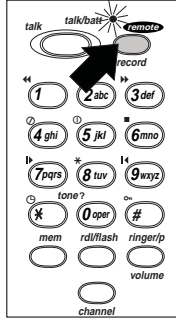

2. Press *****.

The time and day each message was received is announced after the message is played.

** If you want to stop reviewing your messages, press **▶**.*

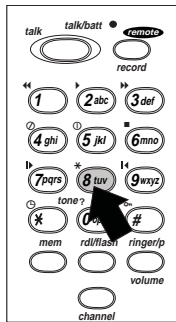

3. When all messages have played, a long tone sounds followed by the announcement "End of messages."



4. Press **remote** to return to Standby.

The talk/batt low LED goes off.

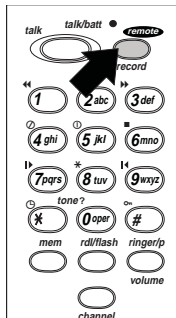

Base Operation

1. Press *****.

The time and day each message was received is announced after the message is played, and the Message Counter LED displays the number of the message playing.

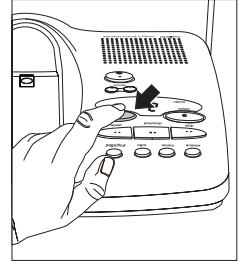

** If you want to stop reviewing your messages, press the **▶**.*

2. When all messages have played, a long tone sounds followed by the announcement "End of messages" plays.



The message counter LED stops flashing, indicating that all of the new messages have been reviewed and stored.

Playing a Stored Message

Handset Operation

1. Press **remote**.

The current Time and Day Stamp and number of new messages is announced.

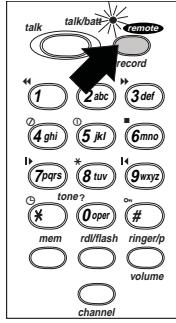

2. Press **▶**.

The number of stored messages is announced, and the first message stored begins playing.

The time and day each message was received is announced after the message is played.

* If you want to stop reviewing your messages, press **▶**.

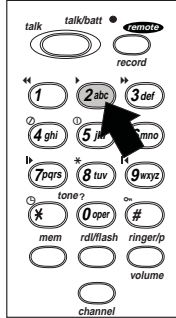

3. When all messages have played, a long tone sounds followed by the announcement "End of messages" plays.

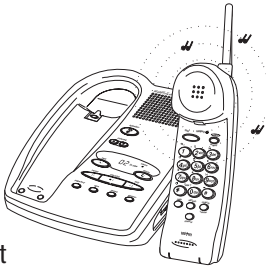

4. Press **remote** to return to Standby.

The talk/batt low LED goes off.

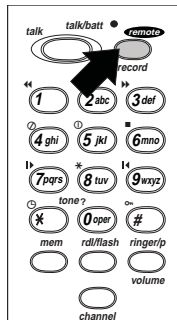

Base Operation

1. Press **▶**.

The number of stored messages is announced.

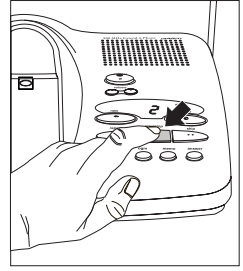

The first message stored begins playing. The time and day each message was received is announced after the message is played. The Message Counter LED displays the number of the message playing.

* If you want to stop reviewing your messages, press **▶**.

2. When all messages have played, a long tone sounds followed by the announcement "End of messages" plays.

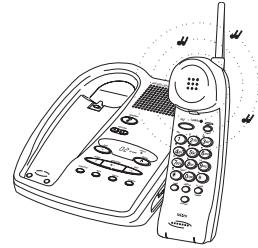

Repeating a Message

Handset Operation

1. Press **remote**.

The current Time and Day Stamp and number of new messages is announced.

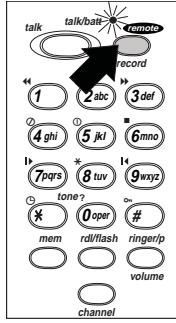

2. Press **▶** to review your messages.



3. Press **◀◀** at anytime to replay a message.

* Pressing **◀◀** during a message returns the system to the beginning of that message.

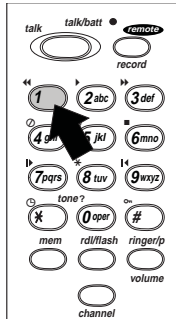

*NOTE: You must wait at least one and a half seconds after the message begins to play to return to the beginning of that message. Pressing **◀◀** again before the message replays for at least one and a half seconds causes the system to scan back one message. If you have several messages, press **◀◀** until you return to the message you want replayed.*

4. To return to Standby, press **remote**.

The talk/batt low LED goes off.

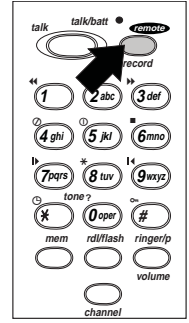

Base Operation

1. Press **■▶** to review your messages.

The number of stored messages is announced.

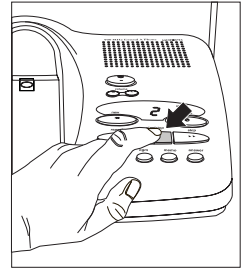

2. Press **◀◀** after the message has played one and a half seconds to replay a message.

* Pressing **◀◀** again before one and a half seconds of the message has played causes the system to scan back one message.

*If you have several messages, press **◀◀** until you return to the message you want replayed.*

3. Press **■▶** at anytime to stop reviewing messages and return to Standby.

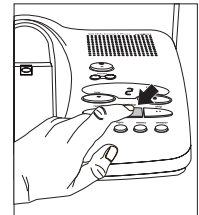

The Message Counter LED shows the total number of messages.

* The system automatically returns to Standby when all messages play.

Skipping a Message

Handset Operation

1. Press **remote**.

The current Time and Day Stamp and number of new messages is announced.

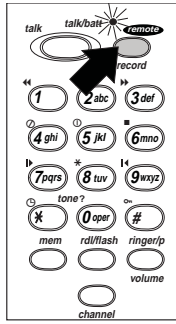

2. Press **▶** to review your messages.

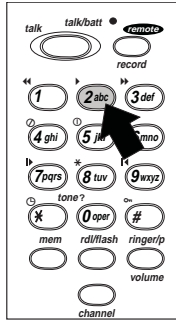

3. Press **▶▶** at anytime to skip to the next message.

✿ Each time you press **▶▶**, the system scans forward one message. If you have several messages, press **▶▶** until you get to the message you want to play.

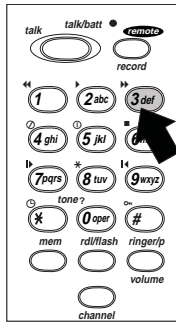

4. To return to Standby, press **remote**.

The **talk/batt low** LED goes off.

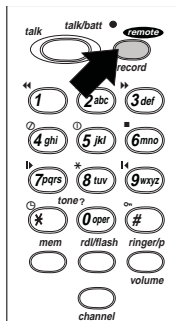

Base Operation

1. Press **▶▶** to review your messages.

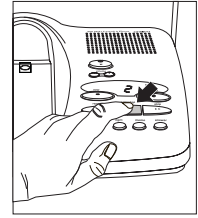

The number of stored messages is announced.

2. Press **▶▶** at anytime to skip to the next message.

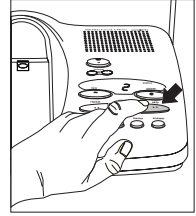

✿ Each time **▶▶** is pressed, the system scans forward one message. If you have several messages, press **▶▶** until you get to the message you want to play.

3. Press **▶▶** at anytime to stop reviewing messages and return to Standby.

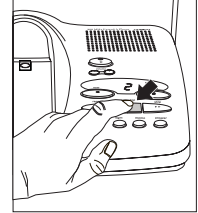

The **Message Counter LED** shows the total number of messages.

✿ The system automatically returns to Standby when all messages play.

Deleting a Message

Handset Operation

1. Press **remote**.

The current Time and Day Stamp and number of new messages is announced.

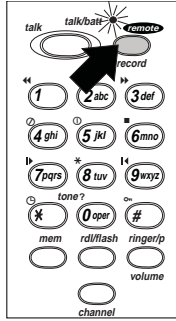

2. Press **▶** to review your messages.

* You can press **▶** when you have received new messages.

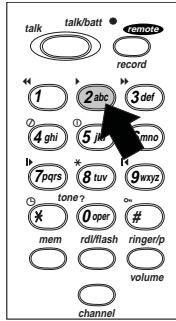

3. If you decide to delete a message, press **⓪** during the message. *The system beeps and immediately goes to the next message.*

* When you press **⓪**, you are deleting the message. Once deleted, the message cannot be replayed.

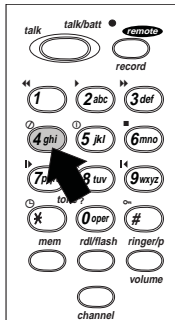

4. You will hear a long tone in the Handset, followed by the "End of messages" announcement.

* The deletion announcement above depends on how many messages you delete during message replay.



Base Operation

1. Press **▶** to review your messages.

* You can press **▶** when you receive new messages.

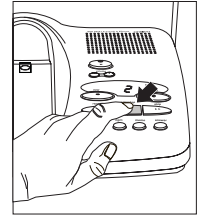

2. If you decide to delete a message, press and release **⓪** anytime during the message.

The system beeps and immediately goes to the next message.

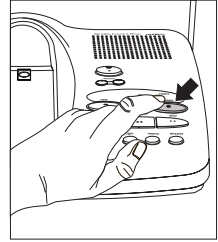

* When you press **⓪**, you are deleting the message. Once deleted, the message cannot be replayed.

3. You will hear a long tone on the Base speaker, followed by the "End of messages" announcement.



Deleting All Messages

You can delete all your messages without deleting each separate message. To delete all the messages, you must use the **delete** button on the Base Unit.

1. Press and hold .

* *You must review all messages before using the "Delete All Messages" function.*

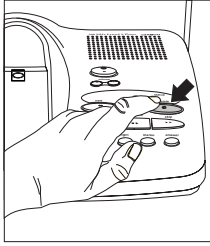

2. You will hear three short tones, followed by a longer tone.

* *If you release the delete button before all three short tones sound, the messages are not erased.*



3. You hear an announcement such as "Two messages deleted" plays.



* *The deletion announcement above depends on how many messages are stored in memory.*

Message Full Indication

The **EXA915** has a maximum record time of 25 minutes or up to 40 incoming messages. When the memory is full, the Answering System will not record incoming calls. To return the system to normal operation, follow these steps.

1. When the memory is full, the phone will ring 10 times before the announcement "No remaining time for incoming messages" plays.



2. You must review your messages and then delete some or all of the stored messages.

Voice-Guided Help Menu

If you are unsure of the commands available while using the Handset, you can use the Voice-Guided Help Menu. The Handset commands are reviewed for you on the Handset Receiver. To access the Help Menu, follow these steps.

1. Press **remote**.

The current Time and Day Stamp and number of new messages is announced.

The talk/batt low LED lights green.

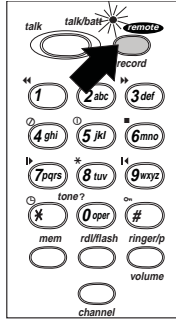

2. Press **?**.

A tone sounds, and the Voice-Guided Menu begins to play.

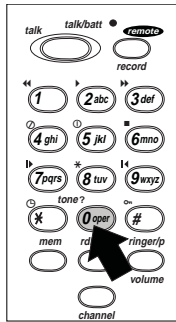

3. There are two ways to exit the Help Menu — press **■** anytime during the review,

- or -
listen to all the options and wait for the system to automatically exit.

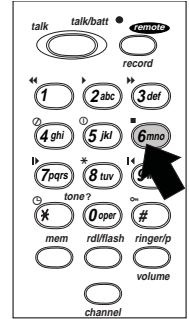

4. When you exit Help, you will hear a short tone every three seconds, indicating the system is in the Command Waiting Mode. Press another command, or press **remote** to return to Standby.

* *You have 20 seconds to enter another command while in the Command Waiting Mode before the system automatically returns to Standby. When you return to Standby, the talk/batt low LED goes off.*

Screening Incoming Calls

If you receive a call while your Answering System is on, you can listen to the incoming message on the Base Unit speaker. If you are away from the Base, you can use your Handset to screen incoming calls.

1. Press **remote** after the phone begins to ring and the **talk/batt low LED lights green.**

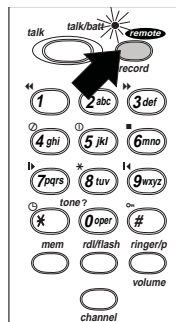

* *The Answering System stops recording the incoming message when you press **talk**.*

3. When you finish the call, press **talk** to hang up.

The talk/batt low LED goes off.

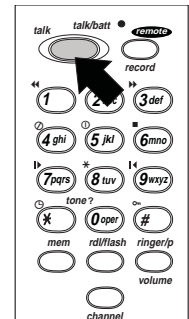

2. You can now listen to the outgoing message and incoming message on the Handset receiver. If you decide to answer the call, press **talk**.

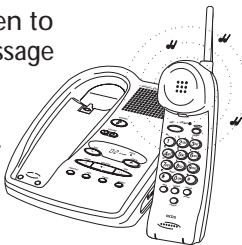

Leaving a Memo Message

You can use the **EXA915** to leave a Memo Message for someone else who uses your Answering System.

1. To record your Memo Message, press and hold **memo** until you hear a long tone and the Message Counter LED begins to count up.

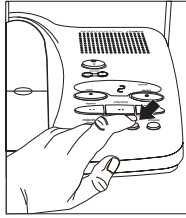

2. Speak into the microphone. When you are finished recording, release the **memo** Button.

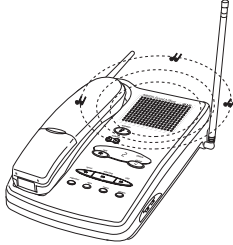

There is a tone, and the Message Counter begins to flash. The Message Counter LED shows the total number of messages stored in memory.

3. After you have recorded your message, the system returns to Standby.

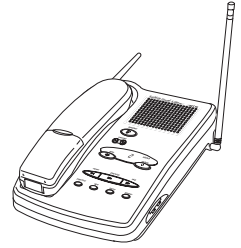

* *If you have new or unplayed messages, the Message Counter LED on the Base Unit continues to flash.*

If all the messages have been reviewed, the Message Counter LED shows the number of messages stored but does not flash.

Recording a Telephone Conversation

To record a conversation during a call:

1. Press **remote**.

The talk/batt low LED changes from red to green, and the telephone sounds warning beeps to let the other party know that the call is being recorded.

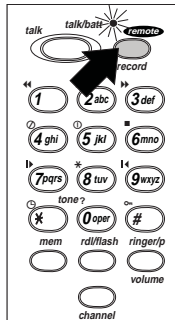

2. To stop recording, press **remote** again.

The talk/batt low LED changes from green back to red.

* *A recorded call is like a message — if you use all of the available record time, the Recording function cancels automatically.*

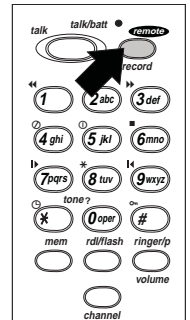

Remote Operation

You can operate your **EXA915** while you're away from home by calling from any touch-tone phone. When using this feature, remember these important guidelines.

- You should change your Personal Identification Number (**PIN**) before using your Handset. When you first apply power, the code is set to 00.
- The dialing keys on a touch-tone phone work the same as the function keys on your phone's Handset except you must press **#** before selecting a command.
- You cannot change the Time and Day Stamp or your **PIN** code from a touch-tone phone.

Setting Your PIN Code

Using the Handset, you can set a personal two-digit code (00 to 99) for your **PIN** code. You must use your **PIN** code to access your Answering System from a touch-tone telephone.

1. Press **remote**.

The current Time and Day Stamp and number of new messages is announced.

The talk/batt low LED lights green.

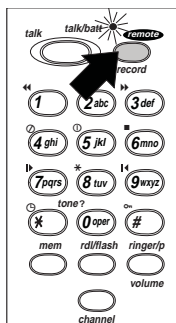

2. Press **On**.

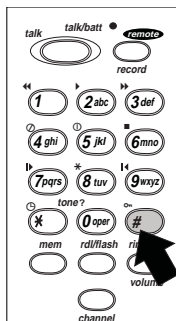

3. Press your two-digit code.

For example, use 22 as the new PIN number.

2abc **2**abc

4. Press **On** again.

You will hear a long tone which indicates that the new code is saved.

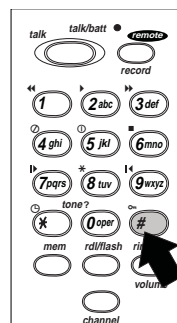

5. Press **remote** again to return to Standby.

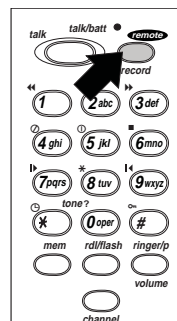

Using a Touch-Tone Phone

You can operate your Answering System using any touch-tone telephone. Use this function to check for recorded messages, play or delete messages, or even record a new outgoing message.

1. Call your telephone number.

2. During the outgoing message playback, press # followed by your PIN number.



For example, use **22** as the new PIN number.

3. The Answering System announces the Time and Day Stamp followed by the number of new messages stored in memory.

4. You then hear intermittent beeps indicating that the system is in the Command Waiting Mode.

* *You must enter a command within 20 seconds or the Answering System hangs up and returns to Standby.*

5. Use this chart to select the function you want to use.

Function	Press
Repeat	#1
Play	#2
Skip	#3
Delete Message	#4
Answer On/Off	#5
Stop	#6
Record OGM	#7
Play New Message	#8
Replay OGM	#9
Help Menu	#0

6. When you've finished, hang up to exit the system.

Your Answering System automatically returns to Standby.

Troubleshooting

If your **EXA915** Integrated Telephone Answering Device is not performing to your expectations, please try these simple steps. If you are still unable to resolve the problems, contact Uniden Customer Service at (800) 297-1023, 8:00 a.m. to 5:00 p.m. Central, Monday through Friday.

Telephone Troubleshooting Chart

Problem	Suggestion
Charge light won't come on when Handset is placed in Base Unit.	Make sure AC Adapter is plugged into the Base Unit and wall outlet. Make sure Handset is properly seated in Base Unit. Make sure that the charging contacts on the Handset and Base Unit are clean.
Audio sounds weak and/or scratchy.	Make sure that the Base Unit antenna is vertical. Move the Handset and/or Base Unit to different locations and try again. Press chan to select another channel.
Can't make or receive calls.	Check both ends of the Base Unit telephone line cord. Make sure the AC Adapter is plugged into the Base Unit and wall outlet. Disconnect the AC Adapter for a few minutes, and then reconnect it.
Handset doesn't ring or receive a page.	Nickel-Cadmium battery pack may be weak. Charge the battery on the Base Unit for 15–20 hours. Extend the Base Unit antenna vertically. The Handset may be too far away from the Base Unit. Place the Base Unit away from noise sources. The Digital Security Code may be erased. Set the Digital Code.
Base Unit doesn't ring or receive a page.	Set the Base Unit Ringer switch to LO or HI .

Answering System Troubleshooting Chart

Problem	Suggestion
Answering System does not work.	Make sure that the Base Unit is plugged in. Make sure the Answering System is turned on. Press the RESET button to reset the system after an AC line spike.
Answering System does not answer calls.	Set the REC TIME/ANN/4/1 switch in either the 4-minute or 1-minute position. The memory may be full. Delete some or all of the saved messages.
Messages are incomplete.	The incoming messages may be too long. Remind callers to leave a brief message. The memory may be full. Delete some or all of the saved messages.
After a power failure, the outgoing message is deleted.	The answering machine has a flash memory with no battery backup. Record your personal outgoing message again. The default messages should still remain.
No sound on the Base Unit speaker during call monitoring or message playback.	Adjust the speaker volume control on the Base Unit.
Cannot access remote call-in features from another touch-tone phone.	Make sure you're using the correct PIN number. Make sure that the touch-tone phone you're using can transmit the tone for at least two seconds. If it cannot, you may have to change to another phone.

Specifications

General – The **EXA915** complies with FCC Rules, Parts 15 and 68.

Frequency Control	Phase Locked Loop (PLL) Synthesizer
Modulation	FM
Operating Temperature	-10° to 50° C

Base Unit

Transmit Frequency	925.994 to 927.952 MHz (40 channels)
Power Requirements	120V AC 60 Hz
Size	178 mm. (W) x 53.8 mm. (D) x 201 mm. (H)
Weight	Approx. 558g.

Handset

Transmit Frequency	902.078 to 904.030 MHz (40 channels)	
Power Requirements	Rechargeable Ni-Cd Battery Pack	
Size (w/ antenna)	55 mm. (W) x 41 mm. (D) x 222 mm. (H)	
Weight	Approx. 209g (including battery)	
Battery		
	Capacity	600 mAh, 3.6V
	Talk Mode	7 hours
	Standby Mode	14 days

Answering System

Memory Type	Digital Tapeless Recording
Memory Capacity	Approx. 20 min. (40 messages)
Message Length	1 min. or 4 min. Incoming Message (max.) 1 min. outgoing message (max.)

Specifications, Features, and availability of Optional Accessories are all subject to change without prior notice.

EXA 915



Operating Guide

900-MHz Integrated Telephone Answering Device

Precautions!

Before you read anything else,
please observe the following:

WARNING!

Uniden America Corporation **DOES NOT** represent this unit to be waterproof. To reduce the risk of fire, electrical shock, or damage to the unit, **DO NOT** expose this unit to rain or moisture.

Rechargeable Nickel-Cadmium Battery Warning

- This equipment contains a Rechargeable Nickel-Cadmium Battery.
- Cadmium is a chemical known to the State of California to cause cancer.
- The Rechargeable Nickel-Cadmium Battery contained in this equipment may explode if disposed of in a fire.
- **Do not** short circuit the battery.
- **Do not** charge the Rechargeable Nickel-Cadmium Battery used in this equipment in any charger other than the one designed to charge this battery as specified in this Guide. Using another charger may damage the battery, or cause the battery to explode.

Rechargeable Nickel-Cadmium Batteries Must Be Recycled or Disposed of Properly

- Residents Of Minnesota should contact 1-800-225-PRBA for information concerning reclamation and disposal of Rechargeable Nickel-Cadmium batteries.
- Residents outside of Minnesota should contact their local authorities for information concerning reclamation and disposal of Rechargeable Nickel-Cadmium batteries.



The exclamation point within an equilateral triangle is intended to alert the user to the presence of important operating and maintenance (servicing) instructions in the literature accompanying the appliance.

Base Unit Controls and Keys

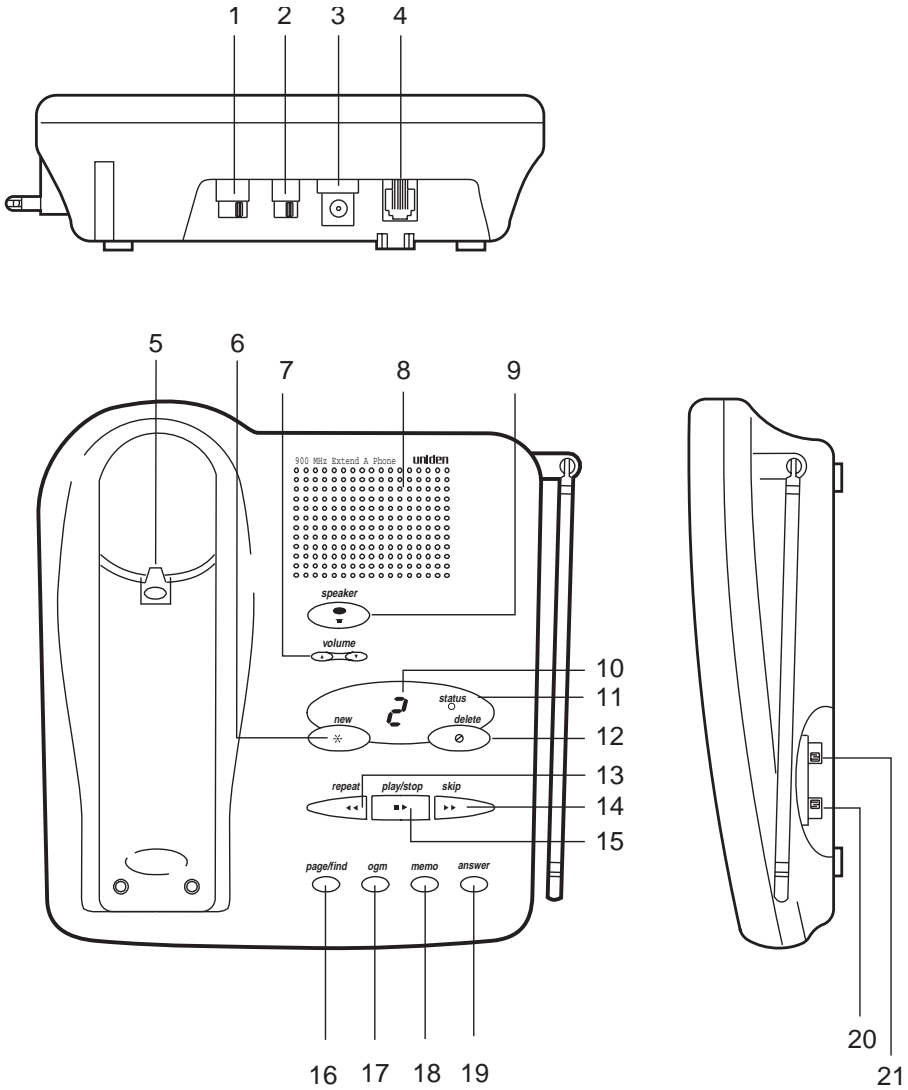

- | | |
|----------------------------------|---------------------------------|
| 1. Ring Volume Off-Lo-Hi Switch | 13. Message Repeat Button ◀◀ |
| 2. Pulse/Tone Switch | 14. Message Skip Button ▶▶ |
| 3. DC Power Jack | 15. Message Play/Stop Button ■▶ |
| 4. Telephone Line Jack | 16. Page/Find Button |
| 5. Handset Retainer | 17. Outgoing Message Button |
| 6. New Message Button and LED ✖ | 18. Memo Button |
| 7. Speaker Volume Control Switch | 19. Answer On/Off Button |
| 8. Speaker | 20. Ring Time 2-4-TS Switch |
| 9. Speakerphone Button and LED | 21. Record Time Ann/4/1 Switch |
| 10. Message Counter LED | |
| 11. Status LED | |
| 12. Message Delete Button | |

Answering Device Remote Keys

1. Remote/Record Button **remote**
2. Repeat Key ◀◀
3. Message Delete Key ⓧ
4. OGM Record Key ▶▶
5. Time/ Day Stamp Reset Key ⌚
6. Play Key ▶
7. Skip Key ▶▶
8. Answer System On/Off Key Ⓜ
9. Stop Key ■
10. Play New Message Key ✕
11. OGM Review Key ◀▶
12. Voice Guided Help Key ?
13. PIN/Security Key **On**

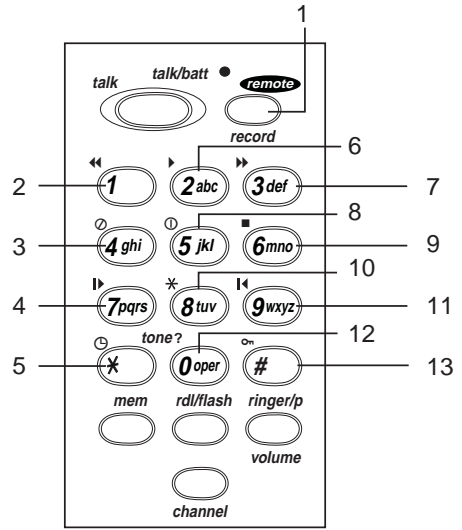

Handset Controls and Keys

1. Talk Button **talk**
 2. Numeric Keypad
 3. Tone Button *
 4. Memory Programming Button **mem**
 5. Redial/Flash Button
 6. Talk/Battery Low Indicator
 7. Pound Key
 8. Ringer/Pause/Volume Button *
 9. Channel Select Button **channel**
 10. Microphone
- * Handset volume control not available on all models of the EXA915.

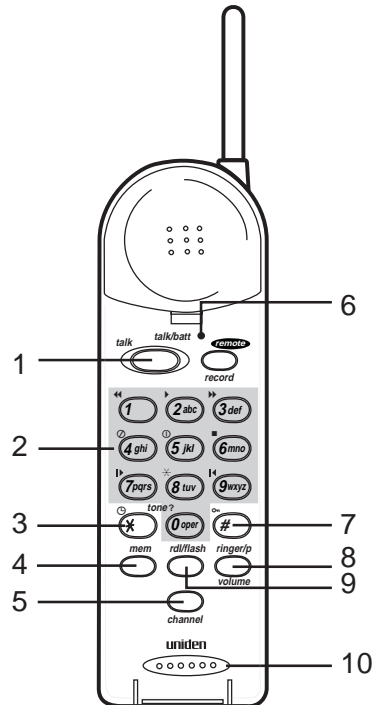

One Year Limited Warranty

Important: Evidence of original purchase is required for warranty service.

WARRANTOR: UNIDEN AMERICA CORPORATION ("Uniden")

ELEMENTS OF WARRANTY: Uniden warrants, for one year, to the original retail owner, this Uniden Product to be free from defects in materials and craftsmanship with only the limitations or exclusions set out below.

WARRANTY DURATION: This warranty to the original user shall terminate and be of no further effect 12 months after the date of original retail sale. The warranty is invalid if the Product is (A) damaged or not maintained as reasonable or necessary, (B) modified, altered, or used as part of any conversion kits, subassemblies, or any configurations not sold by Uniden, (C) improperly installed, (D) serviced or repaired by someone other than an authorized Uniden service center for a defect or malfunction covered by this warranty, (E) used in any conjunction with equipment or parts or as part of any system not manufactured by Uniden, or (F) installed or programmed by anyone other than as detailed by the Operating Guide for this product.

STATEMENT OF REMEDY: In the event that the product does not conform to this warranty at any time while this warranty is in effect, warrantor will repair the defect and return it to you without charge for parts, service, or any other cost (except shipping and handling) incurred by warrantor or its representatives in connection with the performance of this warranty. THE LIMITED WARRANTY SET FORTH ABOVE IS THE SOLE AND ENTIRE WARRANTY PERTAINING TO THE PRODUCT AND IS IN LIEU OF AND EXCLUDES ALL OTHER WARRANTIES OF ANY NATURE WHATSOEVER, WHETHER EXPRESS, IMPLIED OR ARISING BY OPERATION OF LAW, INCLUDING, BUT NOT LIMITED TO ANY IMPLIED WARRANTIES OF MERCHANTABILITY OR FITNESS FOR A PARTICULAR PURPOSE. THIS WARRANTY DOES NOT COVER OR PROVIDE FOR THE REIMBURSEMENT OR PAYMENT OF INCIDENTAL OR CONSEQUENTIAL DAMAGES. Some states do not allow this exclusion or limitation of incidental or consequential damages so the above limitation or exclusion may not apply to you.

LEGAL REMEDIES: This warranty gives you specific legal rights, and you may also have other rights which vary from state to state. This warranty is void outside the United States of America.

PROCEDURE FOR OBTAINING PERFORMANCE OF WARRANTY: If, after following the instructions in this Operating Guide you are certain that the Product is defective, pack the Product carefully (preferably in its original packaging). Include evidence of original purchase and a note describing the defect that has caused you to return it. The Product should be shipped freight prepaid, by traceable means, or delivered, to warrantor at:

Uniden America Corporation
Parts and Service Division
4700 Amon Carter Boulevard
Fort Worth, TX 76155
(800) 297-1023, 8 AM to 5 PM Central, Monday through Friday

Covered under one or more of the following U.S. patents:
4,511,761 4,595,795 4,797,916 4,523,058 5,426,690

uniden®